

HANGING BANNER 8FT ROUND 24IN



Product Features

The Skybox Fabric Hanging Banner is a must have at your next trade show. These extra large hanging banners are produced from high quality fabric and enable you to be seen from practically anywhere at your trade show. Available in round, square, and triangle configurations as well as numerous sizes, there is a Skybox Hanging Banner that would suit almost any situation. This particular model is 8ft wide and 2ft tall. Includes soft carry bag.

Graphic Size	301.59"W x 26"H (includes 2inches of bleed for height)
Display Size	8' Diameter x 24" H

Finishing

Hem with zipper

Printing Material	Fabric
-------------------	--------

Construction

All aluminum frame construction

Weights - Dimensions

Shipping Weight	25 lbs
Shipping Dimensions	72" x 17" x 9"





Graphic Specification

301.59"W x 26"H (includes 2inches of bleed for height)

Graphic Turnaround Time

Standard : 10 business days

Parts List

	
(10) Chain	(24) Spring
	
(4) Curved Stabilizer	
	
(8) Quarter Circle	
	
(1) Nylon Travel Bag	
	
(8) Curved Connector	(4) Eye Hook
	
(4) Large Screw	(10) Hook Loop Lock
	
(1) Screw Tightener	(1) Cable - 10 M

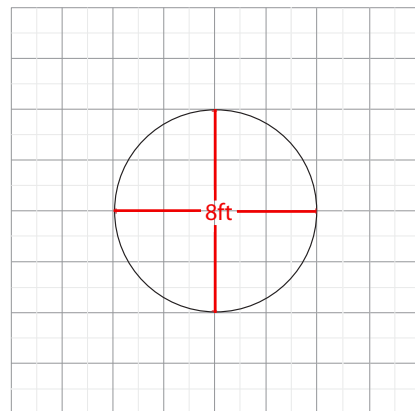

The box represents 16'x16'

HANGING BANNER 8FT ROUND 32IN

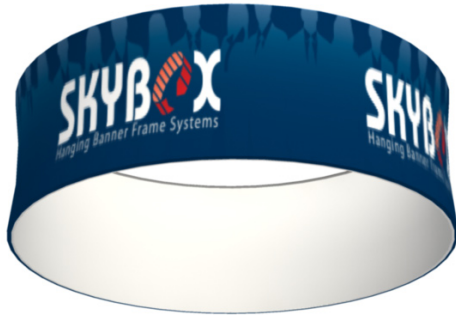

Product Features

The Skybox Fabric Hanging Banner is a must have at your next trade show. These extra large hanging banners are produced from high quality fabric and enable you to be seen from practically anywhere at your trade show. Available in round, square, and triangle configurations as well as numerous sizes, there is a Skybox Hanging Banner that would suit almost any situation. This particular model is 8ft wide and 32 inches tall. Includes soft carry bag.

Graphic Size	301.59"W x 34"H (includes 2inches of bleed for height)
Display Size	8' Diameter x 32" H

Finishing

Hem with zipper

Printing Material	Fabric
-------------------	--------

Construction

All aluminum frame construction

Weights - Dimensions

Shipping Weight	25 lbs
Shipping Dimensions	72" x 17" x 9"









Graphic Specification

301.59"W x 34"H (includes 2inches of bleed for height)

Graphic Turnaround Time

Standard : 10 business days

Parts List

	
(10) Chain	(24) Spring
	
(4) Curved Stabilizer	
	
(8) Quarter Circle	
	
(1) Nylon Travel Bag	
	
(8) Curved Connector	(4) Eye Hook
	
(4) Large Screw	(10) Hook Loop Lock
	
(1) Screw Tightener	(1) Cable - 10 M

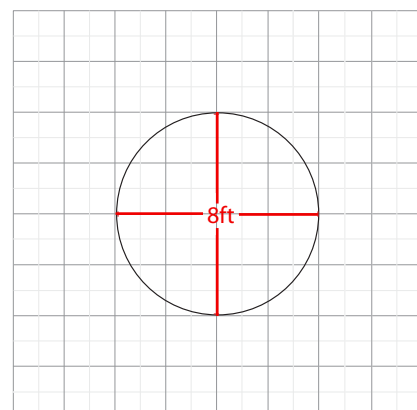

The box represents 16'x16'

HANGING BANNER 8FT ROUND 42IN



Product Features

The Skybox Fabric Hanging Banner is a must have at your next trade show. These extra large hanging banners are produced from high quality fabric and enable you to be seen from practically anywhere at your trade show. Available in round, square, and triangle configurations as well as numerous sizes, there is a Skybox Hanging Banner that would suit almost any situation. This particular model is 8ft wide and 42 inches tall. Includes soft carry bag.

Graphic Size 301.59"W x 44"H
(includes 2 inches of bleed for height)

Display Size 8' Diameter x 42" H

Finishing

Hem with zipper

Printing Material Fabric

Construction

All aluminum frame construction

Weights - Dimensions

Shipping Weight 26 lbs

Shipping Dimensions 72" x 17" x 9"

Graphic Specification

301.59"W x 44"H (includes 2 inches of bleed for height)

Graphic Turnaround Time

Standard : 10 business days

Parts List

	
(10) Chain	(24) Spring
	
(4) Curved Stabilizer	
	
(8) Quarter Circle	
	
(1) Nylon Travel Bag	
	
(8) Curved Connector	(4) Eye Hook
	
(4) Large Screw	(10) Hook Loop Lock
	
(1) Screw Tightener	(1) Cable - 10 M

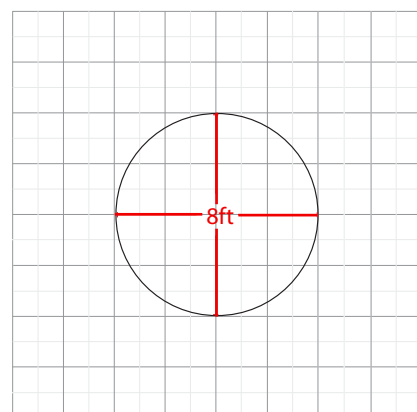

The box represents 16'x16'

HANGING BANNER 8FT ROUND 48IN



Product Features

The Skybox Fabric Hanging Banner is a must have at your next trade show. These extra large hanging banners are produced from high quality fabric and enable you to be seen from practically anywhere at your trade show. Available in round, square, and triangle configurations as well as numerous sizes, there is a Skybox Hanging Banner that would suit almost any situation. This particular model is 8ft wide and 4ft tall. Includes soft carry bag.

Graphic Size	301.59"W x 50"H (includes 2inches of bleed for height)
Display Size	8' Diameter x 48" H

Finishing

Hem with zipper

Printing Material	Fabric
-------------------	--------

Construction

All aluminum frame construction

Weights - Dimensions

Shipping Weight	26 lbs
Shipping Dimensions	72" x 17" x 9"

Graphic Specification

301.59"W x 50"H (includes 2inches of bleed for height)

Graphic Turnaround Time

Standard : 10 business days

Parts List

	
(10) Chain	(24) Spring
	
(4) Curved Stabilizer	
	
(8) Quarter Circle	
	
(1) Nylon Travel Bag	
	
(8) Curved Connector	(4) Eye Hook
	
(4) Large Screw	(10) Hook Loop Lock
	
(1) Screw Tightener	(1) Cable - 10M

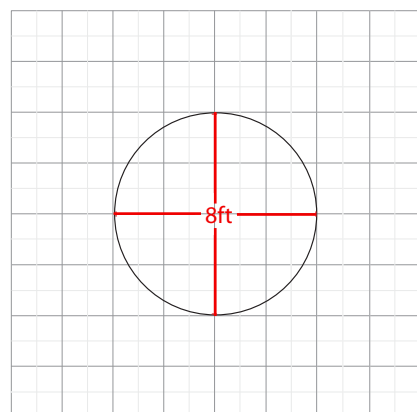

The box represents 16'x16'

HANGING BANNER 10FT ROUND 42IN



Product Features

The Skybox Fabric Hanging Banner is a must have at your next trade show. These extra large hanging banners are produced from high quality fabric and enable you to be seen from practically anywhere at your trade show. Available in round, square, and triangle configurations as well as numerous sizes, there is a Skybox Hanging Banner that would suit almost any situation. This particular model is 10ft wide and 42 inches tall. Includes soft carry bag.

Graphic Size	376.991"W x 44"H (includes 2inches of bleed for height)
Display Size	10' Diameter x 42"H

Finishing

Hem with zipper

Printing Material	Fabric
-------------------	--------

Construction

All aluminum frame construction

Weights - Dimensions

Shipping Weight	29 lbs
Shipping Dimensions	61"x 15"x 9"



Graphic Specification

376.991"W x 44"H (includes 2inches of bleed for height)

Graphic Turnaround Time

Standard : 10 business days

Parts List

	
(8) Chain	(36) Spring
	
(6) Curved Stabilizer	
	
(12) Quarter Circle	
	
(1) Nylon Travel Bag	
	
(12) Curved Connector	(3) Eye Hook
	
(9) Large Screw	(8) Hook Loop Lock
	
(1) Screw Tightener	(1) Cable - 9 M

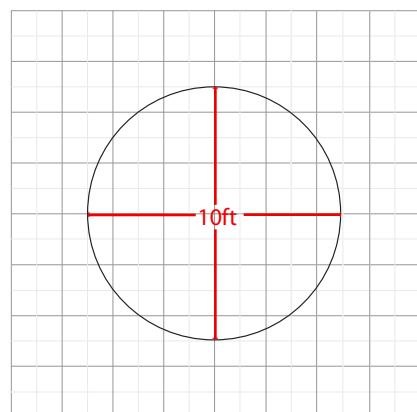

The box represents 16'x16'

HANGING BANNER 10FT ROUND 48IN



Product Features

The Skybox Fabric Hanging Banner is a must have at your next trade show. These extra large hanging banners are produced from high quality fabric and enable you to be seen from practically anywhere at your trade show. Available in round, square, and triangle configurations as well as numerous sizes, there is a Skybox Hanging Banner that would suit almost any situation. This particular model is 10ft wide and 4ft tall. Includes soft carry bag.

Graphic Size	376.991"W x 50"H (includes 2inches of bleed for height)
Display Size	10' Diameter x 48" H

Finishing

Hem with zipper

Printing Material	Fabric
-------------------	--------

Construction

All aluminum frame construction

Weights - Dimensions

Shipping Weight	29 lbs
Shipping Dimensions	61" x 15" x 9"

Graphic Specification

376.991"W x 50"H (includes 2inches of bleed for height)

Graphic Turnaround Time

Standard : 10 business days

Parts List

	
(8) Chain	(36) Spring
	
(6) Curved Stabilizer	
	
(12) Quarter Circle	
	
(1) Nylon Travel Bag	
	
(12) Curved Connector	(3) Eye Hook
	
(9) Large Screw	(8) Hook Loop Lock
	
(1) Screw Tightener	(1) Cable - 9 M

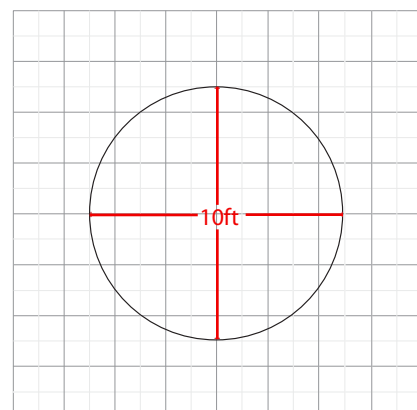

The box represents 16'x16' booth.

HANGING BANNER 12FT ROUND 42IN



Product Features

The Skybox Fabric Hanging Banner is a must have at your next trade show. These extra large hanging banners are produced from high quality fabric and enable you to be seen from practically anywhere at your trade show. Available in round, square, and triangle configurations as well as numerous sizes, there is a Skybox Hanging Banner that would suit almost any situation. This particular model is 12ft wide and 42 inches tall. Includes soft carry bag.

Graphic Size	452.389"W x 44"H (includes 2inches of bleed for height)
Display Size	12 Diameter x 42" H

Finishing

Hem with zipper

Printing Material	Fabric
-------------------	--------

Construction

All aluminum frame construction

Weights - Dimensions

Shipping Weight	32 lbs
Shipping Dimensions	80" x 15" x 9"

Pricing

Frame with graphic	\$1999.00
--------------------	-----------

Graphic Specification

452.389"W x 44"H (includes 2inches of bleed for height)

Graphic Turnaround Time

Standard : 10 business days

Parts List

	
(8) Chain	(36) Spring
	
(6) Curved Stabilizer	
	
(12) Quarter Circle	
	
(1) Nylon Travel Bag	
	
(12) Curved Connector	(3) Eye Hook
	
(9) Large Screw	(8) Hook Loop Lock
	
(1) Screw Tightener	(1) Cable - 9 M

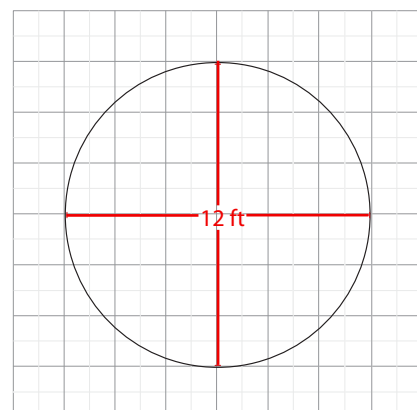

The box represents 16'x16' booth.

HANGING BANNER 12FT ROUND 48IN

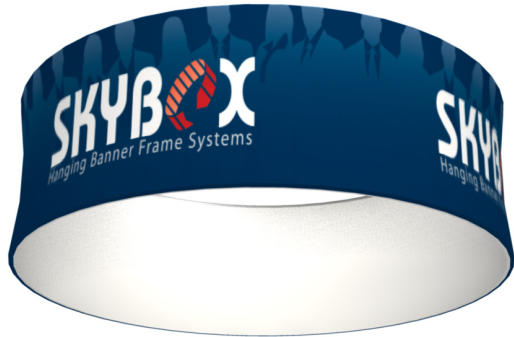

Product Features

The Skybox Fabric Hanging Banner is a must have at your next trade show. These extra large hanging banners are produced from high quality fabric and enable you to be seen from practically anywhere at your trade show. Available in round, square, and triangle configurations as well as numerous sizes, there is a Skybox Hanging Banner that would suit almost any situation. This particular model is 12ft wide and 4ft tall. Includes soft carry bag.

Graphic Size	452.389"W x 50"H (includes 2inches of bleed for height)
Display Size	12 Diameter x 48" H

Finishing

Hem with zipper

Printing Material	Fabric
-------------------	--------

Construction

All aluminum frame construction

Weights - Dimensions

Shipping Weight	32 lbs
Shipping Dimensions	80" x 15" x 9"

Graphic Specification

452.389"W x 50"H (includes 2inches of bleed for height)

Graphic Turnaround Time

Standard : 10 business days

Parts List

	
(8) Chain	(36) Spring
	
(6) Curved Stabilizer	
	
(12) Quarter Circle	
	
(1) Nylon Travel Bag	
	
(12) Curved Connector	(3) Eye Hook
	
(9) Large Screw	(8) Hook Loop Lock
	
(1) Screw Tightener	(1) Cable - 10 M

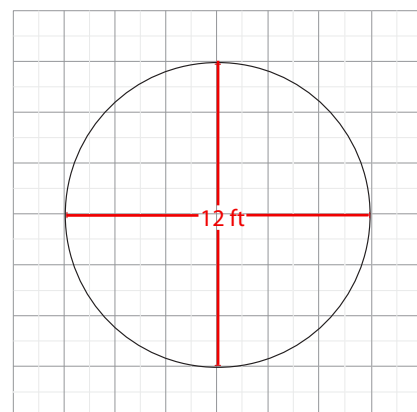

The box represents 16'x16' booth.

HANGING BANNER 15FT ROUND 42IN



Product Features

The Skybox Fabric Hanging Banner is a must have at your next trade show. These extra large hanging banners are produced from high quality fabric and enable you to be seen from practically anywhere at your trade show. Available in round, square, and triangle configurations as well as numerous sizes, there is a Skybox Hanging Banner that would suit almost any situation. This particular model is 15ft wide and 42inches tall. Includes soft carry bag.

Graphic Size	565.486"W x 44"H (includes 2inches of bleed for height)
Display Size	15' Diameter x 42" H

Finishing

Hem with zipper

Printing Material	Fabric
-------------------	--------

Construction

All aluminum frame construction

Weights - Dimensions

Shipping Weight	39 lbs
Shipping Dimensions	72" x 17" x 9"







Graphic Specification

565.486"W x 44"H (includes 2inches of bleed for height)

Graphic Turnaround Time

Standard : 10 business days

Parts List

	
(10) Chain	(48) Spring
	
(8) Curved Stabilizer	
	
(16) Quarter Circle	
	
(1) Nylon Travel Bag	
	
(16) Curved Connector	(4) Eye Hook
	
(12) Large Screw	(10) Hook Loop Lock
	
(1) Screw Tightener	(1) Cable - 13.8 M

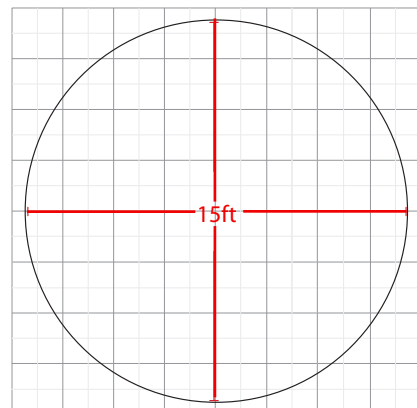

The box represents 16'x16'

HANGING BANNER 15FT ROUND 48IN

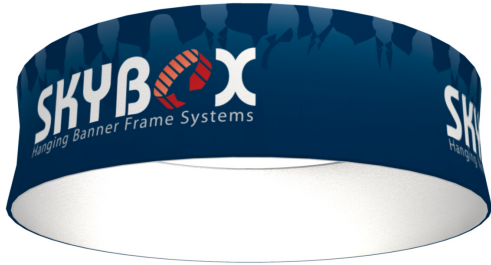

Product Features

The Skybox Fabric Hanging Banner is a must have at your next trade show. These extra large hanging banners are produced from high quality fabric and enable you to be seen from practically anywhere at your trade show. Available in round, square, and triangle configurations as well as numerous sizes, there is a Skybox Hanging Banner that would suit almost any situation. This particular model is 15ft wide and 4ft tall. Includes soft carry bag.

Graphic Size	565.486"W x 50"H (includes 2inches of bleed for height)
Display Size	15' Diameter x 48" H

Finishing

Hem with zipper

Printing Material	Fabric
-------------------	--------

Construction

All aluminum frame construction

Weights - Dimensions

Shipping Weight	39 lbs
Shipping Dimensions	72" x 17" x 9"









Graphic Specification

565.486"W x 50"H (includes 2inches of bleed for height)

Graphic Turnaround Time

Standard : 10 business days

Parts List

	
(10) Chain	(48) Spring
	
(16) Curved Stabilizer	
	
(16) Quarter Circle	
	
(1) Nylon Travel Bag	
	
(16) Curved Connector	(4) Eye Hook
	
(12) Large Screw	(10) Hook Loop Lock
	
(1) Screw Tightener	(1) Cable - 13.8 M

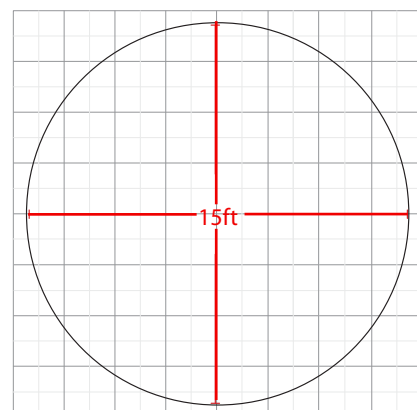

The box represents 16'x16'